

Diagnose – EKG – 10-adrige EKG-Komplettkabel
Diagnostic – ECG – 10 lead ECG complete cable

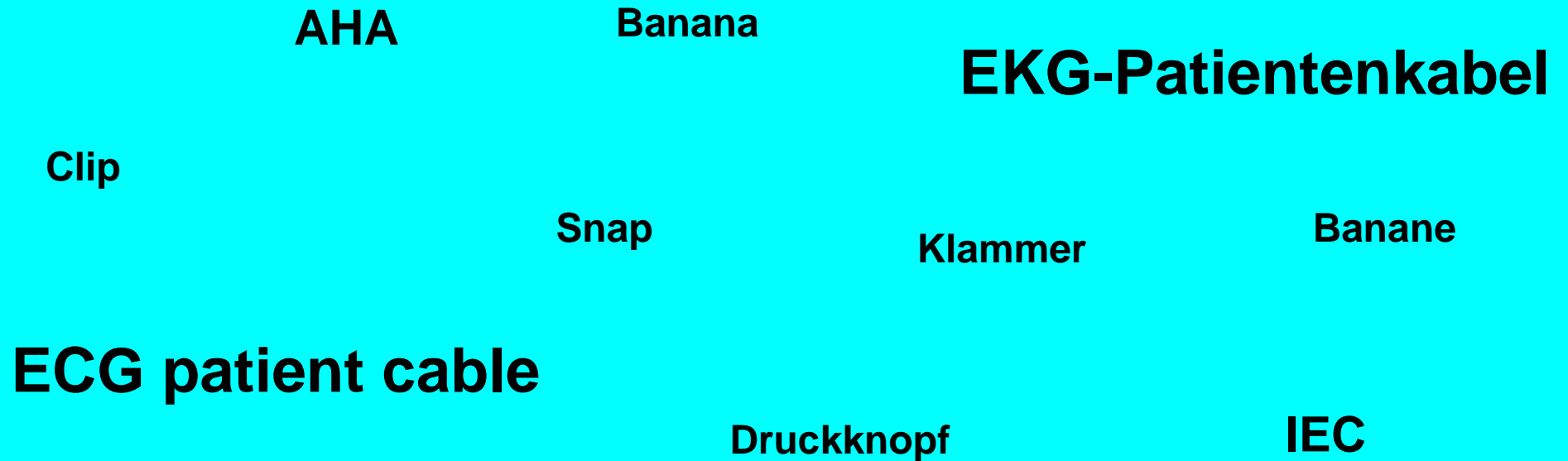

Das Qualitätsprogramm für die MEDIZINTECHNIK
The quality program for MEDICAL TECHNOLOGY



Rev. A11-2022

Diagnose – EKG – 10 adrige EKG-Komplettkabel Diagnostic – ECG – 10 lead ECG complete cable



Farbcode / Colour code

**Farbcode IEC mit Bananenstecker 4 mm = DIA-XXXXXX.3
Colour code IEC with 4 mm banana plug = DIA-XXXXXX.3**

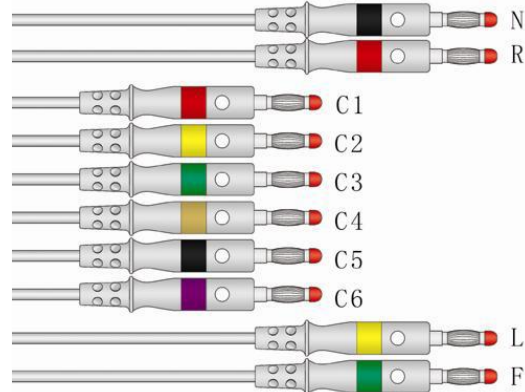

**Farbcode IEC mit Klammer 4 mm = DIA-XXXXXX.2
Colour code IEC with clip = DIA-XXXXXX.2**

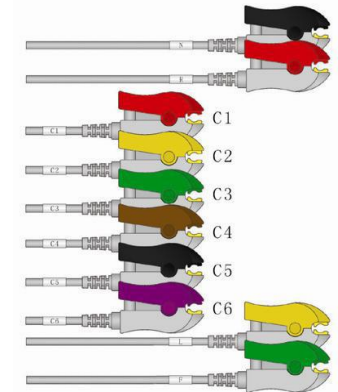

**Farbcode IEC mit Druckknopf 4 mm = DIA-XXXXXX.1
Colour code IEC with snap = DIA-XXXXXX.1**

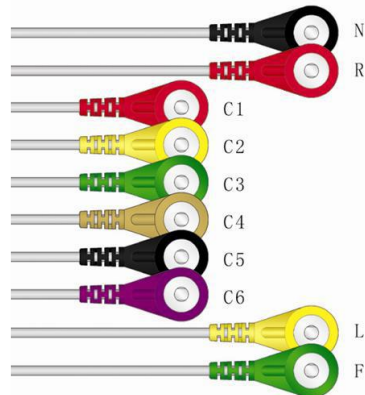

**Farbcode AHA auf Anfrage
Colour code AHA on request**

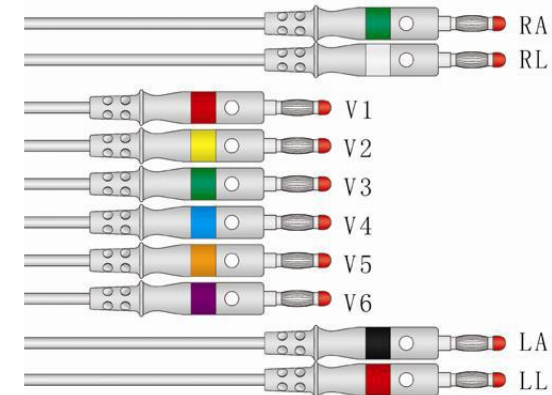

Diagnose – EKG – 10 adrige EKG-Komplettkabel Diagnostic – ECG – 10 lead ECG complete cable



Komplettkabel – Complete cable

Abbildung Art.Nr. DIA-601126.3 (4mm Bananenstecker)
Picture REF DIA-601126.3 (4 mm banana plug)



Abbildung Art.Nr. DIA-191126.1 (Druckknopf)
Picture REF DIA-191126.1 (Snap)



Abbildung Art.Nr. DIA-401060.2 (Klammer)
Picture REF DIA-401060.2 (Clip)



**Stammkabel Länge 210 cm; 10 x Einzelleitungen (Farbcode IEC); 4 x Extremitätenableitungen Länge 110 cm; 6 x Brustwandableitungen Länge 80 cm
Trunkcable length 210 cm; 10 x leadwires (Colour code IEC); 4 x limb leads length 110 cm; 6 x chest leads length 80 cm**

Diagnose – EKG – 10 adrige EKG-Komplettkabel

Diagnostic – ECG – 10 lead ECG complete cable

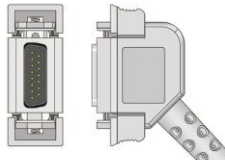
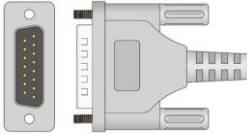
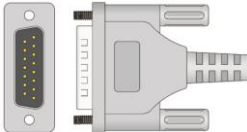
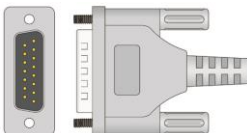
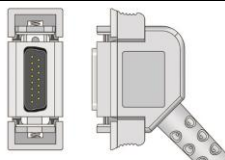

Hersteller Manufacturer	EKG-Gerätetyp ECG Device Type	Leitungen Leads	Komplettkabel Complete Cable Art.Nr. - REF	Stecker plug	Geräte-Stecker Device Connector
Amedtec	ECGpro	10-adrig 10-lead	DIA-601126.3 DIA-601126.2 DIA-601126.1	4 mm Banane Klammer / Clip Druckknopf / Snap	
Aspel	AsCard 3 (1.Generation)	10-adrig 10-lead	DIA-401060.3 DIA-401060.2 DIA-401060.1	4 mm Banane Klammer / Clip Druckknopf / Snap	
Aspel	AsCard3, 4, A4, B5, MrGreen2, MrGREy MrRed, MrBlue, MrSilver3, MrGold, MrCoral, MrAmber	10-adrig 10-lead	DIA-701263.3 DIA-701263.2 DIA-701263.1	4 mm Banane Klammer / Clip Druckknopf / Snap	
Avionics / Del Mar	910, 920, 930, 940, 942, 950, 960, 970, 980	10-adrig 10-lead	DIA-601126.3 DIA-601126.2 DIA-601126.1	4 mm Banane Klammer / Clip Druckknopf / Snap	
Bionet	Cardio Care 2000, Cardio 7, Bionet 7, Cardio Touch 3000 u.a./and others	10-adrig 10-lead	DIA-601126.3 DIA-601126.2 DIA-601126.1	4 mm Banane Klammer / Clip Druckknopf / Snap	
Bosch / Dimeq	603D / 603ER / 603S / 606	10-adrig 10-lead	DIA-401060.3 DIA-401060.2 DIA-401060.1	4 mm Banane Klammer / Clip Druckknopf / Snap	

Diagnose – EKG – 10 adrige EKG-Komplettkabel Diagnostic – ECG – 10 lead ECG complete cable

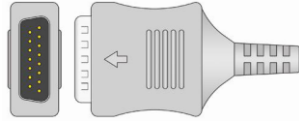
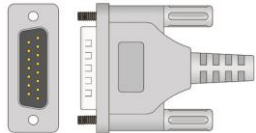
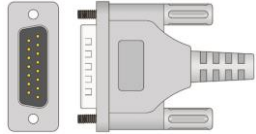
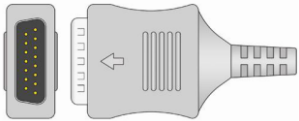
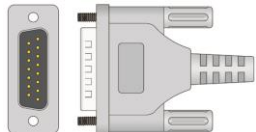
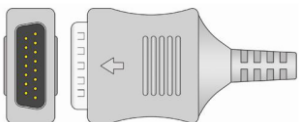

Hersteller Manufacturer	EKG-Gerätetyp ECG Device Type	Leitungen Leads	Komplettkabel Complete Cable Art.Nr. - REF	Stecker plug	Geräte-Stecker Device Connector
Bosch / Dimeq	EK 501, 501 A, 501 NV, 503, 503 B, 503 D, 503 NV, 503 V, 506, 506 D, 601	10-adrig 10-lead	DIA-701285.3 DIA-701285.2 DIA-701285.1	4 mm Banane Klammer / Clip Druckknopf / Snap	
BTL	BTL-08, LC plus, SD 3, MT plus	10-adrig 10-lead	DIA-601126.3 DIA-601126.2 DIA-601126.1	4 mm Banane Klammer / Clip Druckknopf / Snap	
BTL	BTL-08, LC plus, SD 3, MT plus	10-adrig 10-lead	DIA-701252.3 DIA-701252.2 DIA-701252.1	4 mm Banane Klammer / Clip Druckknopf / Snap	
Burdick	E 350, E 550, E 560, EK 10, ELITE, ELITE II	10-adrig 10-lead	DIA-701285.3 DIA-701285.2 DIA-701285.1	4 mm Banane Klammer / Clip Druckknopf / Snap	
Burdick	ECLIPSE LE/Lei (ab/from S/N 1051), Burdick Ref. 007705	10-adrig 10-lead	DIA-701263.3 DIA-701263.2 DIA-701263.1	4 mm Banane Klammer / Clip Druckknopf / Snap	
Cambridge	VS 6, SC 1000	10-adrig 10-lead	DIA-701285.3 DIA-701285.2 DIA-701285.1	4 mm Banane Klammer / Clip Druckknopf / Snap	



Diagnose – EKG – 10 adrige EKG-Komplettkabel Diagnostic – ECG – 10 lead ECG complete cable

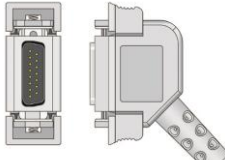
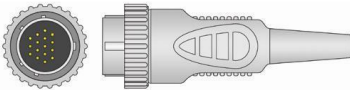
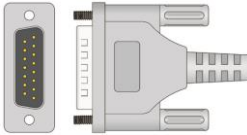
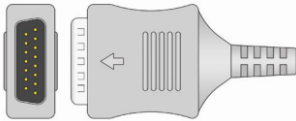
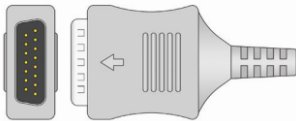
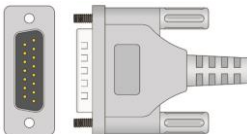

Hersteller Manufacturer	EKG-Gerätetyp ECG Device Type	Leitungen Leads	Komplettkabel Complete Cable Art.Nr. - REF	Stecker plug	Geräte-Stecker Device Connector
Cambridge	CM 6000, CM 6400	10-adrig 10-lead	DIA-401060.3 DIA-401060.2 DIA-401060.1	4 mm Banane Klammer / Clip Druckknopf / Snap	
Cardioline	Delta 1, 3, 30, 60 Delta 1 Plus, Delta 3 Plus Delta 60 Plus	10-adrig 10-lead	DIA-801494.3 DIA-801494.2 DIA-801494.1	4 mm Banane Klammer / Clip Druckknopf / Snap	
Cardioline	alle Cardiette Typen all Cardiette types, EKG 100L EKG 100S, EKG 100+, EKG 200S, EKG 200+	10-adrig 10-lead	DIA-601126.3 DIA-601126.2 DIA-601126.1	4 mm Banane Klammer / Clip Druckknopf / Snap	
Cardioline	E 1, 1 R/3, Delta 300/360	10-adrig 10-lead	DIA-701285.3 DIA-701285.2 DIA-701285.1	4 mm Banane Klammer / Clip Druckknopf / Snap	
Cardionics	Ale EKG Typen, All ECG Types	10-adrig 10-lead	DIA-701285.3 DIA-701285.2 DIA-701285.1	4 mm Banane Klammer / Clip Druckknopf / Snap	
Cardiorapid	K-11, K-111, K-112, K-131, K-31, K-33, K-36	10-adrig 10-lead	DIA-601126.3 DIA-601126.2 DIA-601126.1	4 mm Banane Klammer / Clip Druckknopf / Snap	

Diagnose – EKG – 10 adrige EKG-Komplettkabel Diagnostic – ECG – 10 lead ECG complete cable

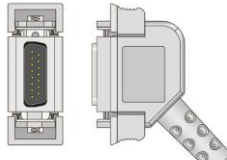
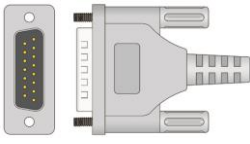
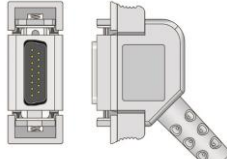
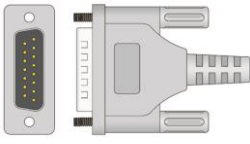

Hersteller Manufacturer	EKG-Gerätetyp ECG Device Type	Leitungen Leads	Komplettkabel Complete Cable Art.Nr. - REF	Stecker plug	Geräte-Stecker Device Connector
ChoiceMMed	OBSERVER MD100A OBSERVER MD100B OBSERVER MD100E	3-adrig 3-lead	DIA-10015	Druckknopf / Snap	
Creative	PC-80B	3-adrig 3-lead	DIA-10023	Druckknopf / Snap	
Custo-med	Custo-Card	10-adrig 10-lead	DIA-401060.3 DIA-401060.2 DIA-401060.1	4 mm Banane Klammer / Clip Druckknopf / Snap	
Custo-med	Custo-Norm	10-adrig 10-lead	DIA-601126.3 DIA-601126.2 DIA-601126.1	4 mm Banane Klammer / Clip Druckknopf / Snap	
Deگو	Cardiomed 3	10-adrig 10-lead	DIA-401060.3 DIA-401060.2 DIA-401060.1	4 mm Banane Klammer / Clip Druckknopf / Snap	
Del Mar / Avionics	910, 920, 930, 940, 942, 950, 960, 970, 980	10-adrig 10-lead	DIA-601126.3 DIA-601126.2 DIA-601126.1	4 mm Banane Klammer / Clip Druckknopf / Snap	

Diagnose – EKG – 10 adrige EKG-Komplettkabel Diagnostic – ECG – 10 lead ECG complete cable



Hersteller Manufacturer	EKG-Gerätetyp ECG Device Type	Leitungen Leads	Komplettkabel Complete Cable Art.Nr. - REF	Stecker plug	Geräte-Stecker Device Connector
Dr.Gerhard Schmidt	SmartScript PC-EKG SmartScript PC-ECG	10-adrig 10-lead	DIA-701288.3 DIA-701288.2 DIA-701288.1	4 mm Banane Klammer / Clip Druckknopf / Snap	
Dr. Vetter	PC-EKG PC-ECG	10-adrig 10-lead	DIA-601125.3 DIA-601125.2 DIA-601125.1	4 mm Banane Klammer / Clip Druckknopf / Snap	
EDAN	ECG- ECG- SE-1010, SE-601-Series,SE-12- EXPRESS, SE-12, SE-1200-EXPRESS,SE-1, SE-3 Series, ST-1212 Ref. MS1-106902	10-adrig 10-lead	DIA-701288.3 DIA-701288.2 DIA-701288.1	4 mm Banane Klammer / Clip Druckknopf / Snap	
Ellettronica Trentina / Cardiette	Cardio Rapid K3 Serie Cardio Rapid series	10-adrig 10-lead	DIA-401060.3 DIA-401060.2 DIA-401060.1	4 mm Banane Klammer / Clip Druckknopf / Snap	
Ellettronica Trentina / Cardiette	alle / all Excel Typwen / types Excel, 101, 103, 106 Cardiorapid K-131, Autoruler 12/1, 12/3 Microruler 12/1, 12/3, Microtel	10-adrig 10-lead	DIA-601126.3 DIA-601126.2 DIA-601126.1	4 mm Banane Klammer / Clip Druckknopf / Snap	
Ellettronica Trentina / Cardiette	Alle / all ARV-/ ADV- Typen / types AR 1200, AR 1200 ADV, Start 100, 100H, 200, 200HV	10-adrig 10-lead	DIA-601126.3 DIA-601126.2 DIA-601126.1	4 mm Banane Klammer / Clip Druckknopf / Snap	

Diagnose – EKG – 10 adrige EKG-Komplettkabel Diagnostic – ECG – 10 lead ECG complete cable



Hersteller Manufacturer	EKG-Gerätetyp ECG Device Type	Leitungen Leads	Komplettkabel Complete Cable Art.Nr. - REF	Stecker plug	Geräte-Stecker Device Connector
Ergoline	Ergoscript, Autoscript, Autoruler, Cardiette EK 3003, EK 3012 Ergoline	10-adrig 10-lead	DIA-601126.3 DIA-601126.2 DIA-601126.1	4 mm Banane Klammer / Clip Druckknopf / Snap	
Esaote Biomedica	P80, P 80 white, P 80 mPower, P120	10-adrig 10-lead	DIA-601126.3 DIA-601126.2 DIA-601126.1	4 mm Banane Klammer / Clip Druckknopf / Snap	
Fidelity	LP 3000	10-adrig 10-lead	DIA-601126.3 DIA-601126.2 DIA-601126.1	4 mm Banane Klammer / Clip Druckknopf / Snap	
Fukuda Denshi	FCP 11/ FX 101, MCP 302, FX 2111, FX 7402, FX 4010, FCP 2155	10-adrig 10-lead	DIA-701285.3 DIA-701285.2 DIA-701285.1	4 mm Banane Klammer / Clip Druckknopf / Snap	
Fukuda Denshi	Cardiomax FX-3010, FX-7202, FX-7302, FX-7102, FCP-2201, FCP 2201G, FX101, FX102F, FX 328U, Alpha 500, 501 AX, Alpha 600	10-adrig 10-lead	DIA-101817.3 DIA-101817.2 DIA-101817.1	4 mm Banane Klammer / Clip Druckknopf / Snap	
Fukuda ME	Alpha 1000	10-adrig 10-lead	DIA-601126.3 DIA-601126.2 DIA-601126.1	4 mm Banane Klammer / Clip Druckknopf / Snap	



Diagnose – EKG – 10 adrige EKG-Komplettkabel Diagnostic – ECG – 10 lead ECG complete cable

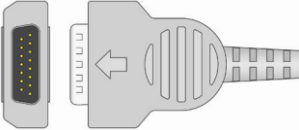
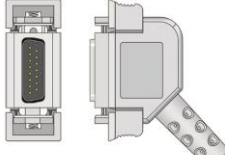
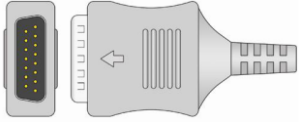
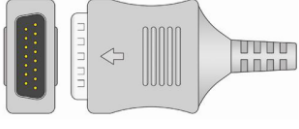
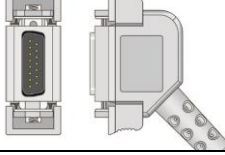
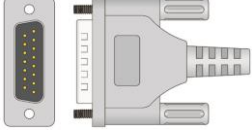

Hersteller Manufacturer	EKG-Gerätetyp ECG Device Type	Leitungen Leads	Komplettkabel Complete Cable Art.Nr. - REF	Stecker plug	Geräte-Stecker Device Connector
GE/ Hellige	MAC 400, MAC500, MAC 800, MAC 1100, MAC 1200, MAC 1600, MAC 2000, Microsmart	10-adrig 10-lead	DIA-101790.3 DIA-101790.2 DIA-101790.1	4 mm Banane Klammer / Clip Druckknopf / Snap	
GE / Hellige	EK 36, EK 41, EK 43, EK 53, EK 56, EK 403, EK 413, EK 512, EK 512 P, EK 512 E CardioSmard, CardioSys, Microlab	10-adrig 10-lead	DIA-401060.3 DIA-401060.2 DIA-401060.1	4 mm Banane Klammer / Clip Druckknopf / Snap	
GE / Hellige	EK 51, Corina	10-adrig 10-lead	DIA-701285.3 DIA-701285.2 DIA-701285.1	4 mm Banane Klammer / Clip Druckknopf / Snap	
Honeywell Philips	Cardioplan ER330, CR300, CR330	10-adrig 10-lead	DIA-701285.3 DIA-701285.2 DIA-701285.1	4 mm Banane Klammer / Clip Druckknopf / Snap	
Hörmann / MWZ	Bioset 3500 / 3600 / 3700 / 6000 / 8000	10-adrig 10-lead	DIA-401060.3 DIA-401060.2 DIA-401060.1	4 mm Banane Klammer / Clip Druckknopf / Snap	
Hörmann / MWZ	Bioset 9000	10-adrig 10-lead	DIA-601126.3 DIA-601126.2 DIA-601126.1	4 mm Banane Klammer / Clip Druckknopf / Snap	

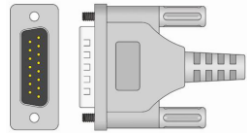
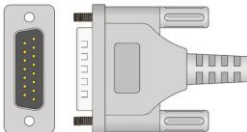
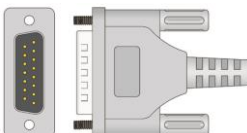
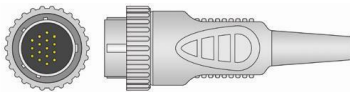
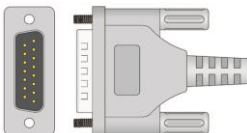

Diagnose – EKG – 10 adrige EKG-Komplettkabel Diagnostic – ECG – 10 lead ECG complete cable



Hersteller Manufacturer	EKG-Gerätetyp ECG Device Type	Leitungen Leads	Komplettkabel Complete Cable Art.Nr. - REF	Stecker plug	Geräte-Stecker Device Connector
HP/Agilent/ PHILIPS	Pagewriter 100, 200, 200i M1770A, M1771A, M1772A Philips Ref.M1770A,M1771A,M1772A	10-adrig 10-lead	DIA-280273.3 DIA-280273.2 DIA-280272.1	4 mm Banane Klammer / Clip Druckknopf / Snap	
Innomed	Heart Mirror 3IUKO, Heartscreen 60G, Heart Screen 80G-L, Heart Screen 112 Visit, Heart Screen 112 Clinic, Cardio PC/E	10-adrig 10-lead	DIA-601126.3 DIA-601126.2 DIA-601126.1	4 mm Banane Klammer / Clip Druckknopf / Snap	
Kenz	ECG 108/ ECG 110 Cardico 302, 601, 1210, 1211	10-adrig 10-lead	DIA-601126.3 DIA-601126.2 DIA-601126.1	4 mm Banane Klammer / Clip Druckknopf / Snap	
Kenz	103, 106	10-adrig 10-lead	DIA-801494.3 DIA-801494.2 DIA-801494.1	4 mm Banane Klammer / Clip Druckknopf / Snap	
Kontron	EKG P80	10-adrig 10-lead	DIA-701322.3 DIA-701322.2 DIA-701322.1	4 mm Banane Klammer / Clip Druckknopf / Snap	
LABTECH	ECG, EKG EC-12R, EC-12R/S, EC-12-RM	10-adrig 10-lead	DIA-202010.3	4 mm Banane	

Diagnose – EKG – 10 adrige EKG-Komplettkabel Diagnostic – ECG – 10 lead ECG complete cable

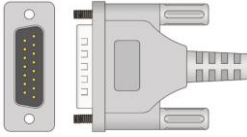
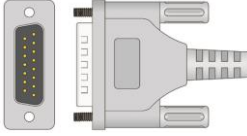
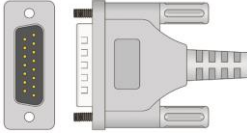
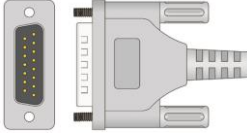

Hersteller Manufacturer	EKG-Gerätetyp ECG Device Type	Leitungen Leads	Komplettkabel Complete Cable Art.Nr. - REF	Stecker plug	Geräte-Stecker Device Connector
LABTECH	ECG, EKG EC-12R, EC-12R/S, EC-12-RM	10-adrig 10-lead	LZE-701287	Druckknopf / Snap	
NORAV	1200-M, 1200-HR, 1200-HR-T, NHH-1200, 1200-S, NECG-3, NECG3+, NECG-12, NECG-12+, NECG-12c, NECG-12c+,	10-adrig 10-lead	DIA-601126.3 DIA-601126.2 DIA-601126.1	4 mm Banane Klammer / Clip Druckknopf / Snap	
Meditech Equipment	EKG 312T EKG 6012	10-adrig 10-lead	DIA-601126.3 DIA-601126.2 DIA-601126.1	4 mm Banane Klammer / Clip Druckknopf / Snap	
MINDRAY	BeneHeart R3, BeneHeart R12 (Ref. 040-001644-00)	10-adrig 10-lead	DIA-601126.3 DIA-601126.2 DIA-601126.1	4 mm Banane Klammer / Clip Druckknopf / Snap	
MESA	CARDIAX PC-EKG (USB) CARDIAX PC-EKG (WiFi) Standard mit 2,1 m Stammkabellänge Standard with 2,1m trunk cable length	10-adrig 10-lead	DIA-191126.3 DIA-191126.2 DIA-191126.1	4 mm Banane Klammer / Clip Druckknopf / Snap	
MESA	CARDIAX PC-EKG (WiFi) mit 1,5 m Stammkabellänge with 1,5 m trunk cable length	10-adrig 10-lead	DIA-701263.1W	Druckknopf / Snap	

Diagnose – EKG – 10 adrige EKG-Komplettkabel Diagnostic – ECG – 10 lead ECG complete cable





Hersteller Manufacturer	EKG-Gerätetyp ECG Device Type	Leitungen Leads	Komplettkabel Complete Cable Art.Nr. - REF	Stecker plug	Geräte-Stecker Device Connector
Medical Econet	Cardio M Cardio M plus Cardio XP	10-adrig 10-lead	DIA-601126.3 DIA-601126.2 DIA-601126.1	4 mm Banane Klammer / Clip Druckknopf / Snap	
Medical Econet	Cardio M PC (USB) PC-EKG Cardio M PC (WiFi) PC-EKG Standard mit 2,1 m Stammkabellänge Standard with 2,1m trunk cable length	10-adrig 10-lead	DIA-191126.3 DIA-191126.2 DIA-191126.1	4 mm Banane Klammer / Clip Druckknopf / Snap	
Medical Econet	Cardio M PC (WiFi) PC-EKG mit 1,5 m Stammkabellänge with 1,5 m trunk cable length	10-adrig 10-lead	DIA-191126.1W	Druckknopf / Snap	
Medset	Flashlight	10-adrig 10-lead	DIA-191126.3 DIA-191126.2 DIA-191126.1	4 mm Banane Klammer / Clip Druckknopf / Snap	
Nihon Kohden	Cardiofax Q, Cardiofax 8110,8240,8270,8330,8340,8350,8370, 8420, 8423, 8450, 8453, 8820, 8823, 8830, ,9010K, 9020,9022,9110,9130K, 9132,9620,PEA-1110, 1350,1250 Ref. Nr.: BJ-9020D / K081	10-adrig 10-lead	DIA-701288.3 DIA-701288.2 DIA-701288.1	4 mm Banane Klammer / Clip Druckknopf / Snap	
Nihon Kohden	Cardiofax 6353, 6151, 6851	10-adrig 10-lead	DIA-701285.3 DIA-701285.2 DIA-701285.1	4 mm Banane Klammer / Clip Druckknopf / Snap	

Diagnose – EKG – 10 adrige EKG-Komplettkabel

Diagnostic – ECG – 10 lead ECG complete cable

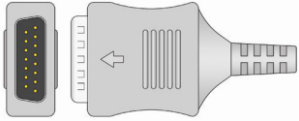
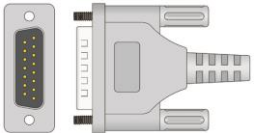
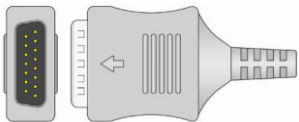
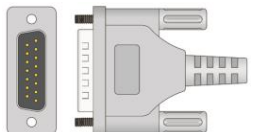

Hersteller Manufacturer	EKG-Gerätetyp ECG Device Type	Leitungen Leads	Komplettkabel Complete Cable Art.Nr. - REF	Stecker plug	Geräte-Stecker Device Connector
Polymed	ALPHA 6600, ALPHA 8800	10-adrig 10-lead	DIA-701285.3 DIA-701285.2 DIA-701285.1	4 mm Banane Klammer / Clip Druckknopf / Snap	
Reynolds / Spacelabs	Cardiotrack 12, Cardiocollect	10-adrig 10-lead	DIA-601126.3 DIA-601126.2 DIA-601126.1	4 mm Banane Klammer / Clip Druckknopf / Snap	
Seca	3000	10-adrig 10-lead	DIA-701285.3 DIA-701285.2 DIA-701285.1	4 mm Banane Klammer / Clip Druckknopf / Snap	
SCHILLER	CS-6, CS-12, CS-6/12, CS-2, AT-3, AT-5, AT-6, AT-10, CS-200 AT-10+, AT-60, AT-100, CS-200 III Schiller Ref. D-109114, Banana Schiller Ref. D 109113, Clip	10-adrig 10-lead	DIA-601126.3 DIA-601126.2 DIA-601126.1	4 mm Banane Klammer / Clip Druckknopf / Snap	
SCHILLER	AT-1, AT-2, AT-2+, AT-4, AT-101, AT-102, AR-102+, AT-104, AT-10+, AT-110, PT-160, CS-200 Excellence Schiller Ref. D 109011, Banana Schiller Ref. D 109026, Clip	10-adrig 10-lead	DIA-701322.3 DIA-701322.2 DIA-701322.1	4 mm Banane Klammer / Clip Druckknopf / Snap	
SCHILLER	MS-2007, MS-2010, MS-2015 Schiller Ref. D 109160, Banana Schiller Ref. D 109161, Clip	10-adrig 10-lead	DIA-701322.3 DIA-701322.2 DIA-701322.1	4 mm Banane Klammer / Clip Druckknopf / Snap	

Diagnose – EKG – 10 adrige EKG-Komplettkabel Diagnostic – ECG – 10 lead ECG complete cable

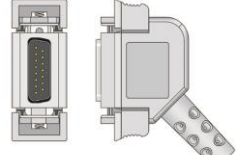
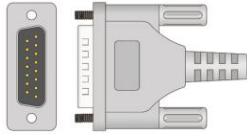
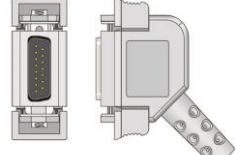
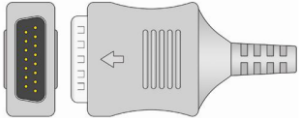
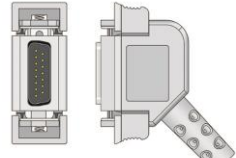

Hersteller Manufacturer	EKG-Gerätetyp ECG Device Type	Leitungen Leads	Komplettkabel Complete Cable Art.Nr. - REF	Stecker plug	Geräte-Stecker Device Connector
SCHILLER	MS-12, FT-1 Ref. D 109165	10-adrig 10-lead	DIA-2310317.3 DIA-2310317.2 DIA-2310317.1	4 mm Banane Klammer / Clip Druckknopf / Snap	
Schwarzer	Cardos 6	10-adrig 10-lead	DIA-401060.3 DIA-401060.2 DIA-401060.1	4 mm Banane Klammer / Clip Druckknopf / Snap	
Schwarzer	Cardos 12, Cardos Light, CU 12	10-adrig 10-lead	DIA-601126.3 DIA-601126.2 DIA-601126.1	4 mm Banane Klammer / Clip Druckknopf / Snap	
SIEMENS	SICARD 440-740, Miracard, Mingocard, Mingophon Mingograf, Mingolog, Mingodoc Sirecard 803, Megacard CARDIOSTAT ab 33, 3T-701-703	10-adrig 10-lead	DIA-401060.3 DIA-401060.2 DIA-401060.1	4 mm Banane Klammer / Clip Druckknopf / Snap	
Trismed	Alle Cardipia Typen All Cardipia types	10-adrig 10-lead	DIA-701285.3 DIA-701285.2 DIA-701285.1	4 mm Banane Klammer / Clip Druckknopf / Snap	
Welch Allyn	CardioPerfect MD PC-EKG CardioPerfect MD PC-ECG	10-adrig 10-lead	DIA-401060.3 DIA-401060.2 DIA-401060.1	4 mm Banane Klammer / Clip Druckknopf / Snap	

Diagnose – EKG – 10 adrige EKG-Komplettkabel Diagnostic – ECG – 10 lead ECG complete cable

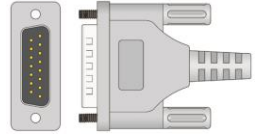
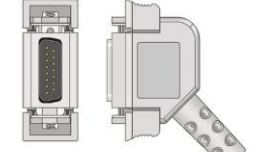
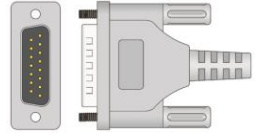

Hersteller Manufacturer	EKG-Gerätetyp ECG Device Type	Leitungen Leads	Komplettkabel Complete Cable Art.Nr. - REF	Stecker plug	Geräte-Stecker Device Connector
Welch Allyn	CardioPerfect PRO PC-EKG CardioPerfect PRO PC-ECG	10-adrig 10-lead	DIA-701287.3 DIA-701287.2 DIA-701287.2	4 mm Banane Klammer / Clip Druckknopf / Snap	
Welch Allyn	CP50, CP 150, CP250	10-adrig 10-lead	DIA-601126.3 DIA-601126.2 DIA-601126.1	4 mm Banane Klammer / Clip Druckknopf / Snap	
Zimmer Medizinsysteme	Cardio 1	10-adrig 10-lead	DIA-401060.3 DIA-401060.2 DIA-401060.1	4 mm Banane Klammer / Clip Druckknopf / Snap	
Zimmer Medizinsysteme	CardioSys, Cardio Pro, Cardio Air, Cardio Smart,	10-adrig 10-lead	DIA-601126.3 DIA-601126.2 DIA-601126.1	4 mm Banane Klammer / Clip Druckknopf / Snap	

Alle Angaben entsprechen den Kenntnissen zum Druckzeitpunkt. Änderungen aufgrund technischer Weiterentwicklung sind vorbehalten

All information is representing the technical product status at date of printing. Changes due to technical advancement are subject to modification of amendment



MESA Medizintechnik GmbH
Schärflmühlweg 4
D-83671 Benediktbeuern
Phone: +49-(0)8857-6918-0
Fax: +49-(0)8857-6918-29
Email: info@mesamed.de
Homepage: www.mesamed.de